

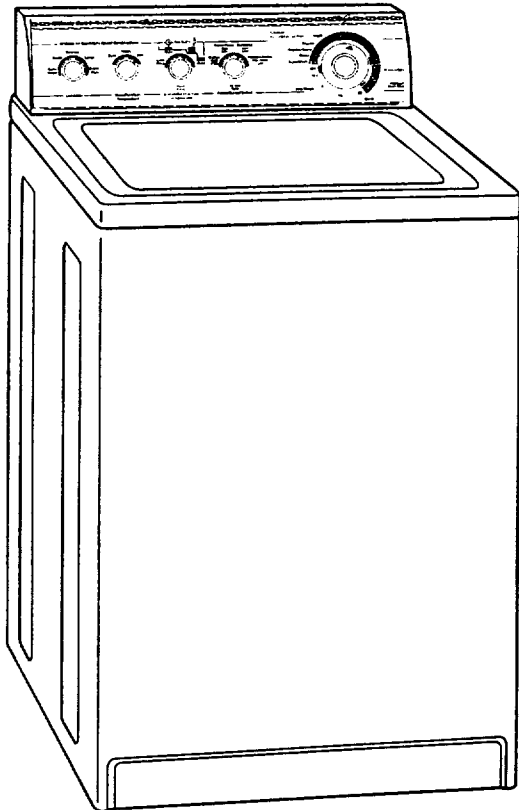

**CONSUMER SERVICES TECHNICAL
EDUCATION GROUP PRESENTS**

L-65



RESOURCE SAVER SPRAY RINSE SYSTEM

SERVICING AND TROUBLESHOOTING

**JOB AID
Part No. 4322534**

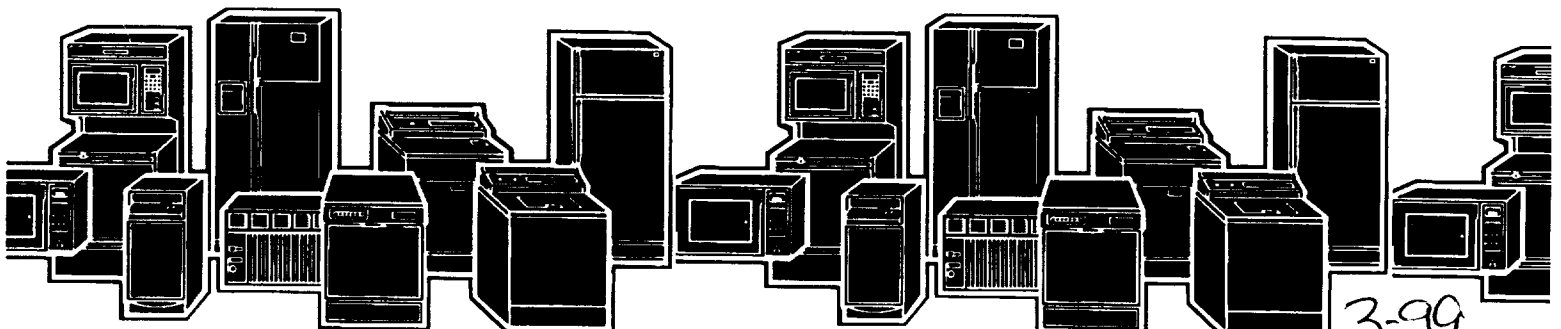

INTRODUCTION

This Job Aid, "RESOURCE SAVER SPRAY RINSE SYSTEM," (Part No. 4322534), provides specific information on the new features and design elements of Direct Drive washers with the Spray Rinse System.

For additional information on the basic Direct Drive Washer, refer to Job Aid Part #787930 and the accompanying Video, Part #787929.

"RESOURCE SAVER SPRAY RINSE SYSTEM" has been compiled to provide the most recent information on design, features, troubleshooting, service and repair procedures.

GOALS AND OBJECTIVES

The goal of this Job Aid is to provide detailed information that will enable the service technician to properly diagnose malfunctions and repair the unique features of Whirlpool Resource Saver washers with the Spray Rinse System.

The objectives of the Job Aid are:

The service technician will -

- Understand proper safety precautions.
- Successfully troubleshoot and diagnose malfunction.
- Successfully perform necessary repairs.
- Successfully return the washer to proper operational status.



WHIRLPOOL CORPORATION ASSUMES NO RESPONSIBILITY
FOR ANY REPAIRS MADE ON OUR PRODUCTS BY ANYONE
OTHER THAN AUTHORIZED SERVICE TECHNICIANS.

TABLE OF CONTENTS

INTRODUCTION	II
TABLE OF CONTENTS	III
SAFETY	III
 SECTION ONE	
THEORY OF OPERATION	1
 SECTION TWO	
COMPONENT ACCESS	
COMPONENT LOCATION	3
ACCESSING CRITICAL COMPONENTS	3
 SECTION THREE	
COMPONENT TESTING & DIAGNOSIS	
AUTOMATIC TEMPERATURE CONTROL TESTS	5
RELAY TEST	7
DIVERTER VALVE SOLENOID TEST	8
 SECTION FOUR	
TECH TIPS	
WIRING DIAGRAM	9
CYCLE TIMING CHART	10
SWITCH CHARTS	11
MODEL AND SERIAL NUMBER PLATE LOCATION	12
MODEL AND SERIAL NUMBER DESIGNATORS	12
GENERAL INFORMATION	13
PRODUCT SPECIFICATIONS AND WARRANTY	
INFORMATION SOURCES	15

SAFETY



WARNING



ELECTRICAL SHOCK HAZARD

Disconnect power before servicing the washer.

Replace all panels before operating the washer.

Failure to do so can result in death or electrical shock.

SECTION ONE

THEORY OF OPERATION

ENERGY STAR DESIGNATION

The Whirlpool Model LSW9245E Clothes Washer is the first top-loader to receive the U.S. Department of Energy and U.S. Environmental Protection Agency Energy Star designation. This designation is identified on the console of the unit by the Energy Star Logo (Fig. 1).

This designation was developed to help consumers quickly and easily identify products that save energy and help protect the environment.



Fig. 1

Energy Saving Features

The Resource Saver Spray Rinse washer is designed to successfully wash clothes with approximately 35% to 47% less water by using a series of "spray rinses" rather than a "deep rinse" commonly used in other conventional washers.

As water is sprayed onto the spinning clothes, they become saturated. The rinse water is then extracted from the spinning clothes and diverted from the basket where it is recirculated and once again, sprayed back onto the spinning clothes. Each spray rinse cycle recirculates the rinse water for thirty seconds, after which the detergent laden water is drained from the basket. This occurs six times. Each spray rinse cycle uses approximately one (1) to two (2) gallons of water.

In addition, these models are equipped with an Automatic Temperature Control system to minimize the amount of hot water used throughout the wash and rinse cycles.

The spray rinse cycle is accomplished through the use of a unique recirculating system, dual vacuum break, a diverter valve, a second pressure switch and an extra pressure dome mounted to the inside back panel of the washer.

Cycle Operation

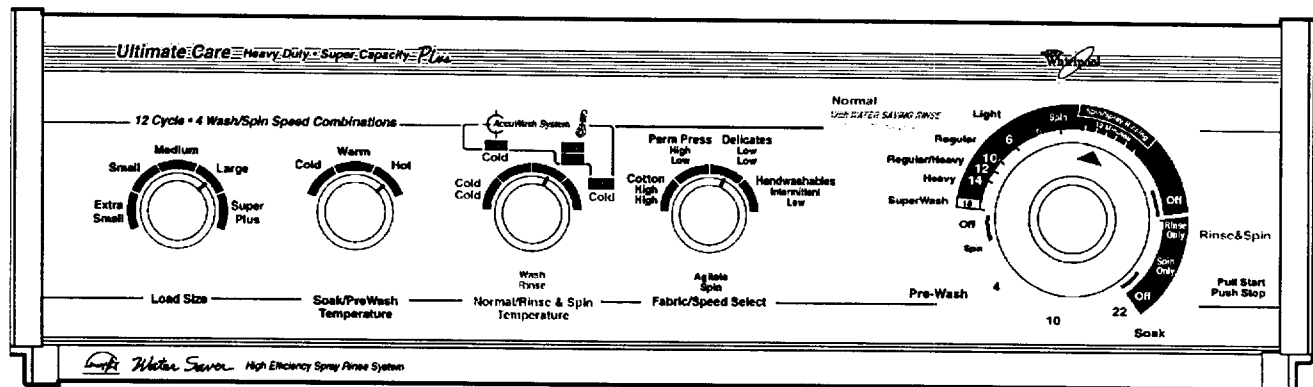

Fig. 2

TWO WATER TEMPERATURE SELECTOR SWITCHES (Fig. 2)

The Resource Saver Spray Rinse washer uses two water temperature switches to determine the wash and/or rinse water temperatures depending on whether the Normal/Rinse & Spin cycle is chosen or the Soak/PreWash cycle is chosen.

NORMAL/RINSE & SPIN TEMPERATURE SWITCH (Fig. 2)

This switch controls the Normal/Rinse & Spin cycle only. The Automatic Temperature Control is employed along with the other unique components of the recirculation system during the spray rinse cycle.

SOAK/PREWASH TEMPERATURE SWITCH (Fig. 2)

This switch controls the water temperature for the Soak and PreWash cycle. There is no rinse feature in this mode.

SPEED SELECTOR SWITCH (Fig. 2)

This switch operates in all cycles and provides the selection of agitate and spin speeds, with the following exceptions:

- Agitation speed will not step down in the normal cycle as with other Whirlpool built Direct Drive washers.
- Spin speed in the normal cycle is selectable at the Spin Indicator ONLY (increment 11). (Fig. 3) The spin will always be high speed during the Spin/Spray Rinse cycle.

Fig. 3

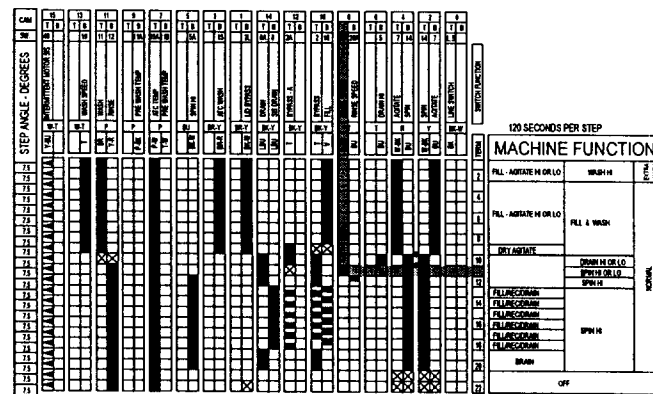

RINSE & SPIN CYCLE

The Rinse & Spin cycle is a traditional Deep Rinse cycle with no washing portion to the cycle.

SPIN/SPRAY RINSE

- During this cycle, fresh water is brought in through the inlet valve and enters the basket from the right side of the vacuum break while the basket is spinning.
- As the clothes become saturated, water is forced into the secondary pressure dome, tripping the rinse pressure switch.
- Fresh water ceases to enter and the existing water is recirculated through the left side of the vacuum break for the approximately 30-seconds.
- The water is then drained from the basket.
- This procedure occurs six (6) times in the Spin/Spray Rinse cycle.
- At the completion of the 6th Spray Rinse cycle, the washer continues to spin for an additional four (4) minutes, during which no additional water is added.

SECTION TWO

ACCESSING CRITICAL COMPONENTS

COMPONENT LOCATION

CONSOLE

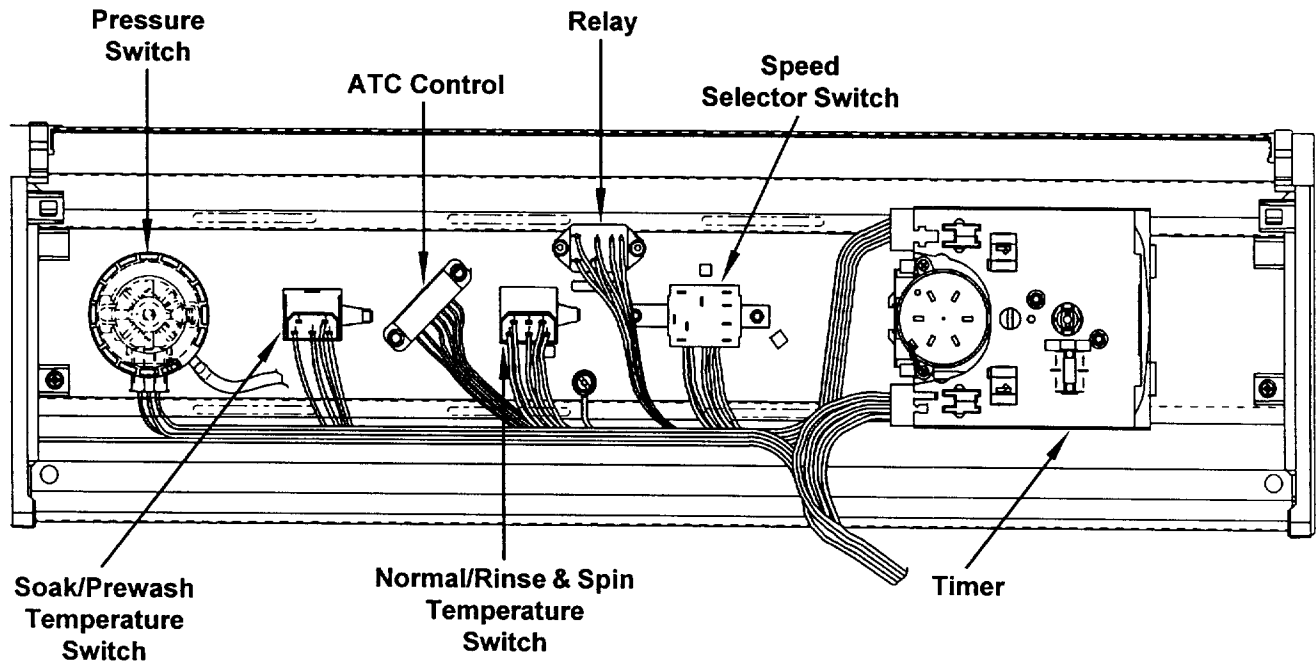

CABINET COMPONENTS

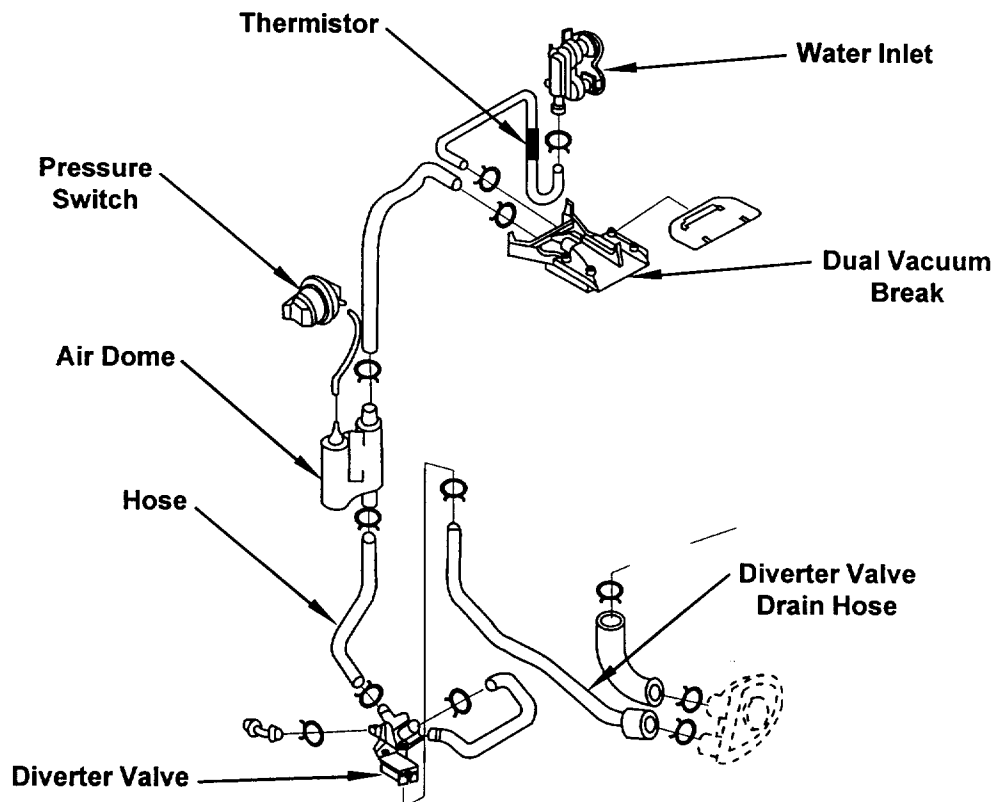

ACCESSING COMPONENTS IN THE CONSOLE

1. Disconnect the power supply to the washer.
2. Remove the two (2) Phillips Head screws securing the lower left and right corners of the console to the washer top.
3. Tilt the console back on the hinges that secure the top of the console to the washer back. (Fig. 4)

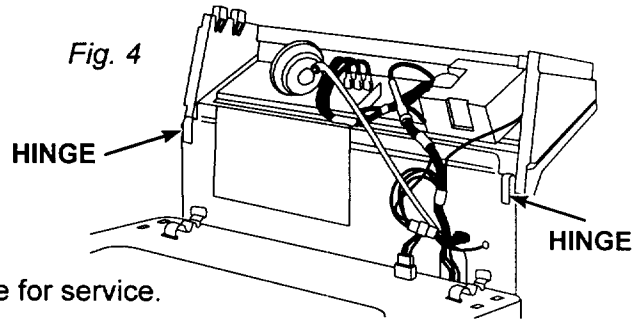

All components in the console are now accessible for service.

ACCESSING COMPONENTS IN THE WASHER CABINET

Components inside the washer cabinet can be accessed by completely removing the outer cabinet as one unit. Refer to *Figure 5* for the following instructions.

1. Remove the console mounting screws and tilt the console into the service position.
2. Unplug the lid switch harness connector from the receptacle in the washer top.
3. Remove the cabinet mounting clips by placing the flat blade of a screwdriver in the clip as shown in *Figure 5, Inset 1*.

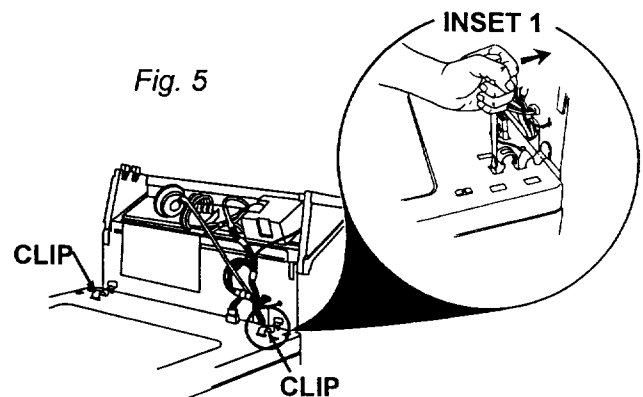

4. Remove the cabinet by tilting it forward and pulling it away from the washer. (Fig. 6)

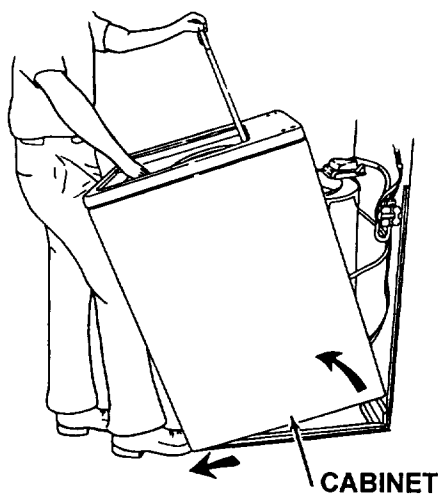

NOTE: When removing the outer cabinet, the basket must be pulled forward to avoid damage to the tub ring shield.

NOTE: If necessary, the washer can be operated in all cycles with the cabinet removed. Install a jumper wire in the lid switch harness connector as shown.

IMPORTANT: Use extreme caution when operating the washer with the cabinet removed.

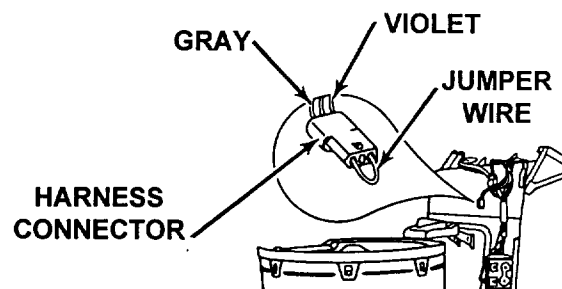



SECTION THREE

DIAGNOSIS AND TROUBLESHOOTING

AUTOMATIC TEMPERATURE CONTROL TESTS

For additional information on the Automatic Temperature Control System, refer to Job Aid #4322334.

 WARNING	
	<p style="text-align: center; margin: 0;">ELECTRICAL SHOCK HAZARD</p> <p style="margin: 5px 0;">Disconnect power before servicing.</p> <p style="margin: 5px 0;">Replace all panels before operating the washer.</p> <p style="margin: 5px 0;">Failure to do so can result in death or electrical shock.</p>

ATC Testing

NOTE: Perform the following tests in sequence.

TEST 1: Non-ATC Wash Fills

NOTE: The non-ATC system must function properly before testing the ATC system.

1. Set the timer to fill cycle and start the washer. Washer will begin filling with water.
2. Turn the water temperature switch to each of the non-ATC positions and note the temperature of the water entering the washer at each position.

If the temperatures are not correct, or the washer is not filling, check the following for proper operation and function.

<u>Component</u>	<u>Problem Check</u>
Timer	No fill
Water Level Switch	No fill or wrong water level
Water Temp Switch	No fill or wrong water temp
Water Valves	No fill or slow fill

Test 2: ATC Wash Fills

This tests the ATC portion of the ATC control.

1. Set the water temp switch to ATC controlled 100°F/COLD.
2. Set the timer to wash fill in the Normal cycle and start the washer. The washer will begin filling with water.

Both the hot and cold valves operate continuously for approximately 55 seconds. After 55 seconds, the cold valve should cycle on and off while the hot valve stays on continuously.

If the cold valve is not working properly:

- Disconnect the washer from the electrical supply.
- Check the ATC board for proper installation in the connector.
- Make sure the harness wires are in the proper location to the connector. (Fig. 7)

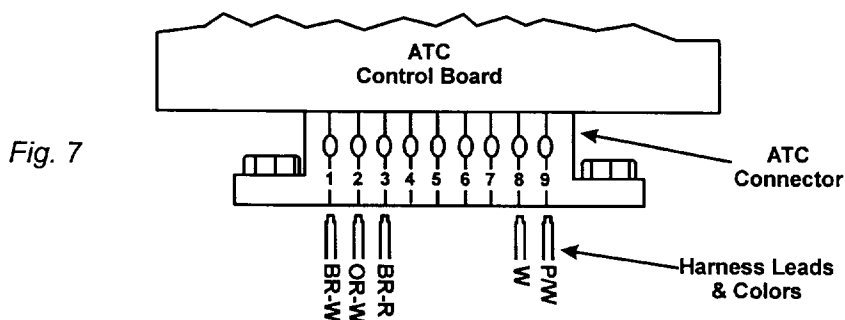

- Remove the ATC control board from the connector.
- Using an ohmmeter, measure the thermistor at connector harness wires 2, (Or-W), and 9, (P-W). Compare the readings to the following "Thermistor Resistance Chart:"

THERMISTOR RESISTANCE CHART	
Temperature Degrees (F)	Resistance (Ohms)
40	126k - 135k
50	97k - 102k
60	75k - 78k
70	58k - 61k
80	46k - 47k
90	36k - 37k
100	28k - 30k
110	23k - 24k
120	18k - 19k
130	15k - 16k
140	12k - 13k
150	10k - 11k

- Note 1:** If the hot water temperature is below 120°F, the cold valve may turn off and stay off.
- Note 2:** If the cold water temperature is above 70°F, the cold valve may stay on continuously.
- Note 3:** If the thermistor is open, the cold valve will stay off. If the thermistor is shorted, the cold valve will stay on continuously.
- Note 4:** When the **Prewash** cycle is selected, the ATC feature is bypassed. This will provide uncontrolled warm and cold wash and all cold rinse for all temp settings.

If ohmmeter reading is not correct:

1. Remove the cabinet.
2. Replace the thermistor and repeat steps 1 and 2 of Test 2.
3. Set the water temp switch to ATC controlled 75°F/75°F
4. Set the timer to **the NORMAL cycle**, and start the washer. The washer will begin filling with water. The Hot valve should cycle on and off while the cold valve operates continuously.

Note: If the cold water temperature is above 65°F, the hot valve may not turn on.

If the hot valve is not working properly:

- Disconnect the washer from the electrical supply.
- Replace the ATC board and repeat steps 3 and 4 above.

Repeat Test 2 for all three (3) ATC controlled water temp switch positions.

Relay Test

A console mounted relay is wired in parallel with the diverter valve solenoid. (Figs. 8a & 8B) This relay is used to bypass timer contact 5A during increment 11 of the spin cycle to energize the motor and timer motor circuit and to provide a spin speed selection during the first two minutes of the spin cycle. The relay contact 4 to 5 is a normally open contact. Energizing the relay coil 7 to 8 will close the contact.

- Set the washer timer to increment 11 of the **Spin** cycle. If the basket does not spin **AND** the timer does not advance, **CHECK** the relay.
1. Disconnect the washer from the electrical supply.
 2. Place the console in the service position.
 3. Disconnect the wire leads from the relay terminals 7 and 8.
 4. Take an ohmmeter reading between terminals 7 and 8. The ohmmeter should read continuity.

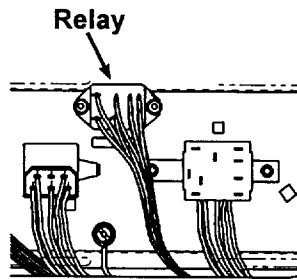

Fig. 8A

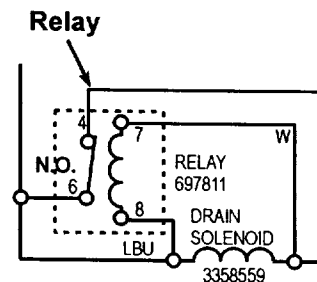

Fig. B

Diverter Valve Solenoid Test

The diverter valve is mounted on the inside back panel of the washer. It is used to direct recirculated water to the left side of the dual vacuum break in the Spin/SprayRinse portion of the NORMAL cycle. The diverter valve solenoid is not energized during the recirculation of spray rinse water. The solenoid, (Figs. 9A & 9B) is wired in parallel with the relay mounted in the console. This solenoid is energized during the drain mode to direct drain water from the basket to the drain hose.

- Set the washer timer to the **Spin** cycle. If the water does not drain after each spray/rinse cycle, **CHECK** the solenoid.
1. Disconnect the washer from the electrical supply.
 2. Place the console in the service position.
 3. Disconnect the wire leads from the relay terminals 7 and 8.
 4. Take an ohmmeter reading between the WIRE leads 7 and 8. This will check the diverter valve solenoid and wiring to the solenoid. The ohmmeter should read continuity.

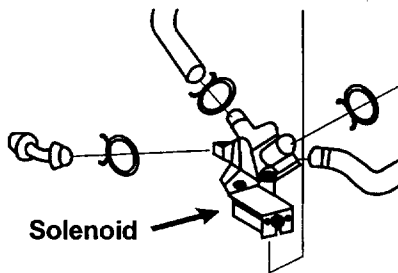

Fig. 9A

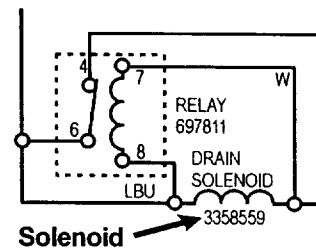
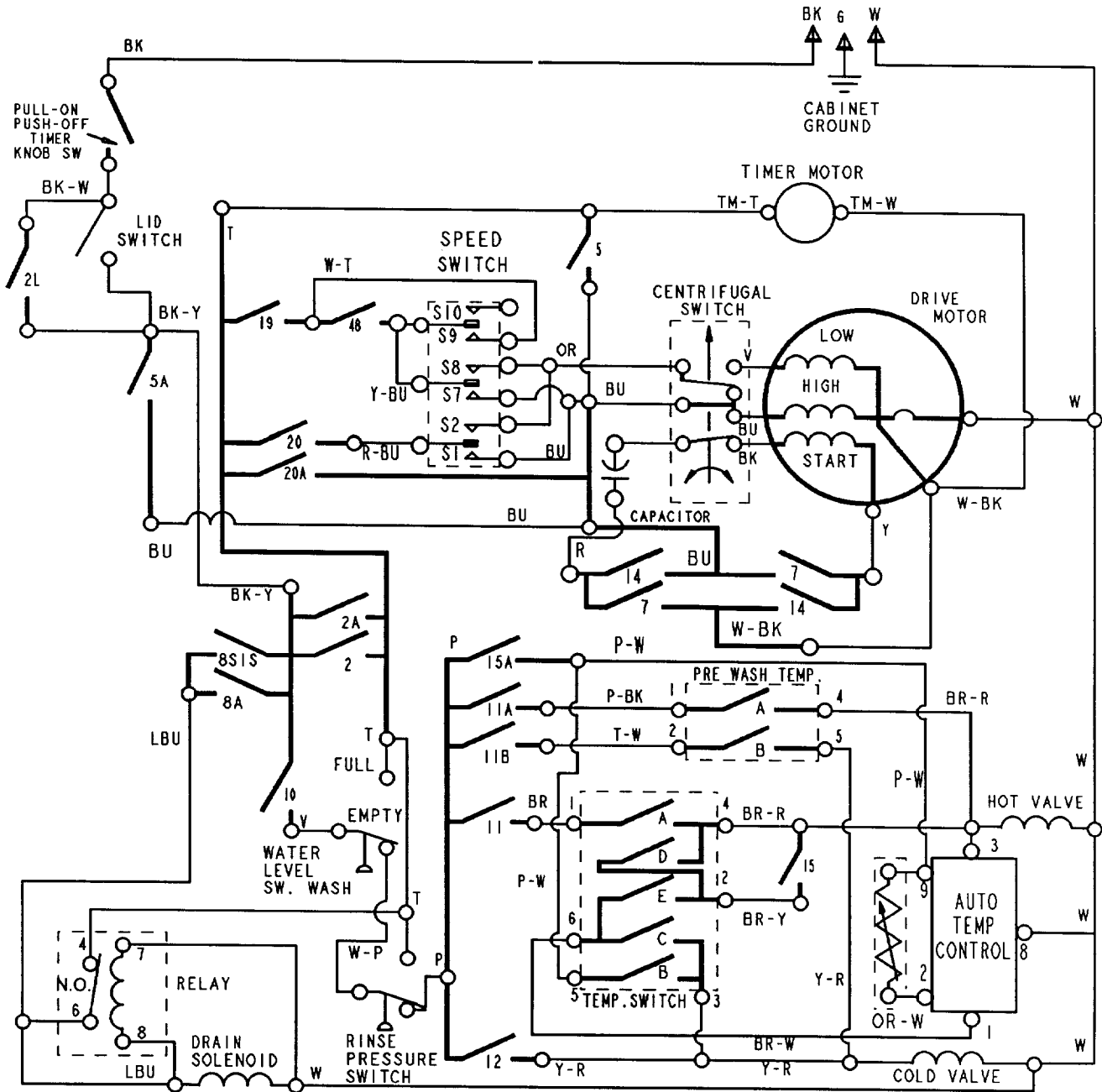

Fig. 9B

SECTION FOUR TECH TIPS WIRING DIAGRAM



LEGEND

- | | | | |
|--|----------------------|--|---------------------|
| | TIMER SWITCH | | HARNES WIRING |
| | SUB-INTERVAL SWITCH | | HARNES CONNECTION |
| | INT. COMP CONNECTION | | TERMINAL CONNECTION |
| | | | S5 SPST SWITCH |
| | | | S6 SPST SWITCH |

CYCLE TIMING CHART

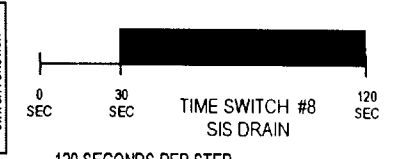
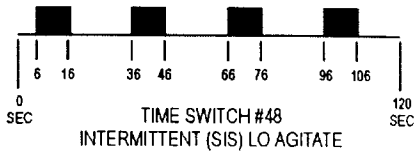
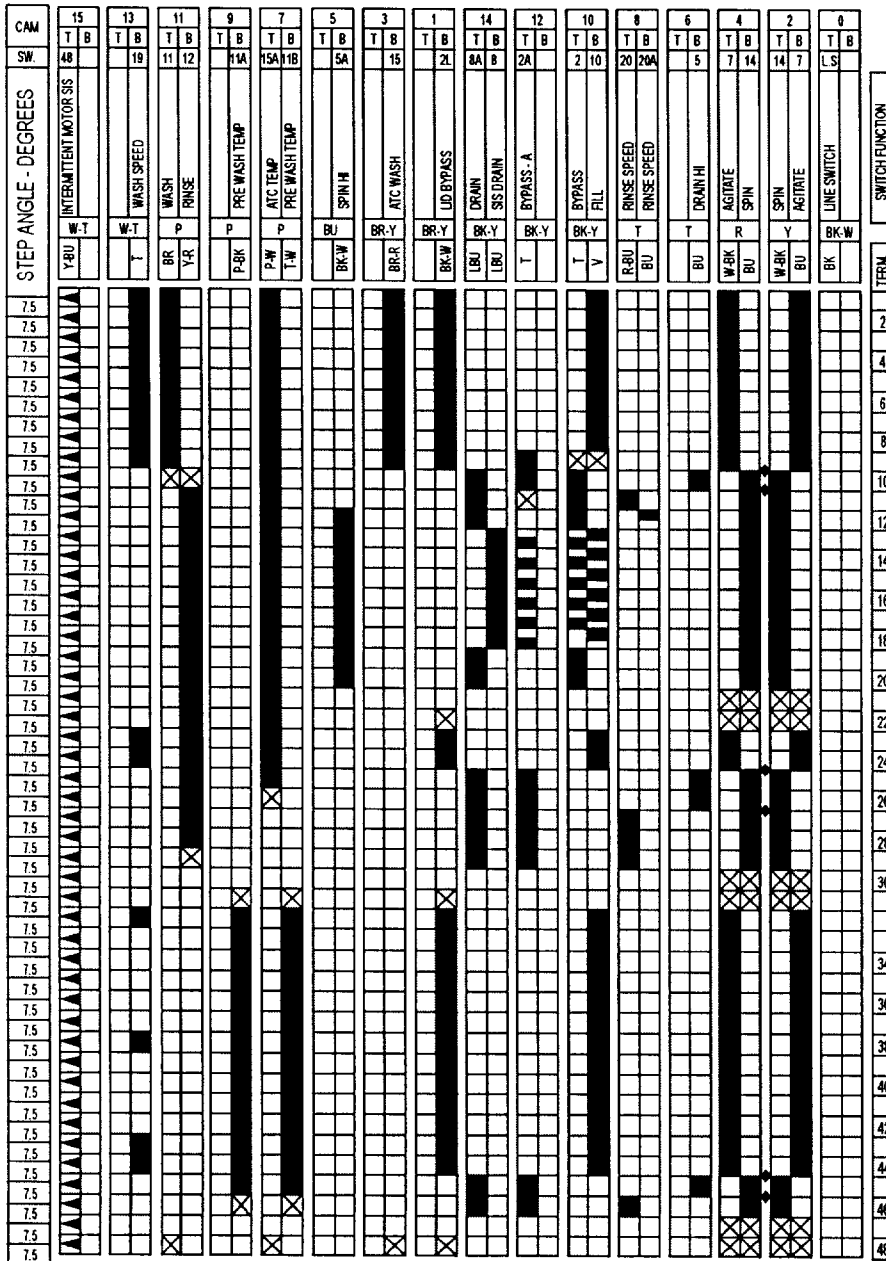

120 SECONDS PER STEP

TERMINAL	MACHINE FUNCTION		
2	FILL - AGITATE HI OR LO	WASH HI	EXTRA WASH
4	FILL - AGITATE HI OR LO	FILL & WASH	NORMAL
6	FILL - AGITATE HI OR LO	FILL & WASH	
8	DRY AGITATE		
10		DRAIN HI OR LO	
12		SPIN HI OR LO	
14	FILL/REC/DRAIN	SPIN HI	NORMAL
16	FILL/REC/DRAIN		
18	FILL/REC/DRAIN		
20	FILL/REC/DRAIN		
22	OFF		
24	FILL - AGITATE HI OR LO	FILL & WASH	RINSE/SPIN
26		DRAIN HI	
28		SPIN HI OR LO	
30	OFF		
34	SOAK	FILL & SOAK	SOAK
38	FILL - AGITATE HI OR LO	FILL & WASH	
42	SOAK	FILL & SOAK	
44	FILL - AGITATE HI OR LO	FILL & WASH	PRE WASH
46		DRAIN HI	
48		SPIN HI OR LO	
	OFF		

X = TIMER SWITCH MAY BE OPEN OR CLOSED

◆ INDICATES MOTOR "OFF"

SWITCH CHARTS

TEMPERATURE SWITCH						
WASH	RINSE	A	B	C	D	E
*HOT	COLD	X		X		
*WARM	*WARM		X		X	X
*WARM	COLD		X			X
COLD	COLD		X			
* WARM = 75° F ± 5°						
* HOT = 100° F ± 5°						

PRE-WASH TEMP SW	SWITCH CLOSED	
	A	B
COLD		X
WARM	X	X
HOT	X	

MOTOR SPEED SWITCH							
FUNCTION		R-BU		Y-BU		Y-BU	
FABRIC	SPEED	OR	BU	BU	OR		W/T
		S2	S1	S7	S8	S10	S9
COTTON	HIGH HIGH		X	X			X
PERM. PRESS	HIGH LOW	X		X			X
DELICATE	LOW LOW	X			X		X
HAND WASH	INT. LOW	X			X		

CONNECTOR BLOCK SCHEMATICS

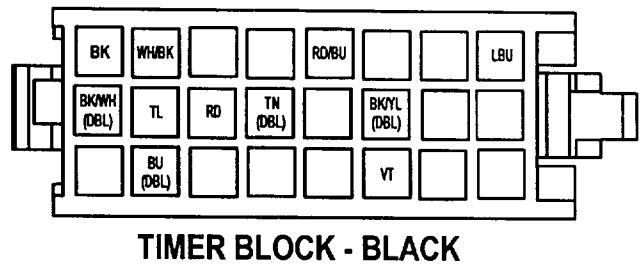
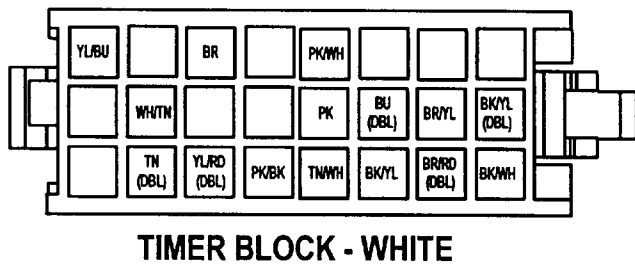
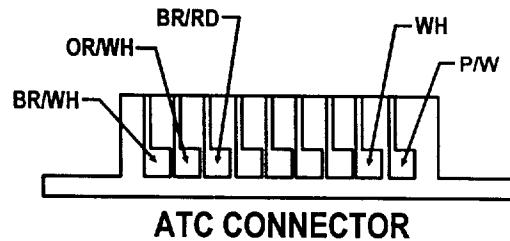
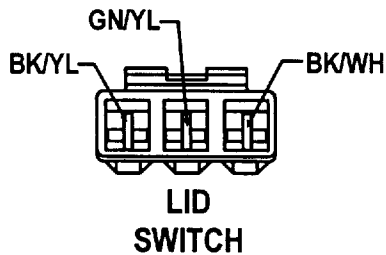

MODEL/SERIAL NUMBER PLATE LOCATION

The Model/Serial Number Plate is located at the back of the opening of the washer top underneath the lid.

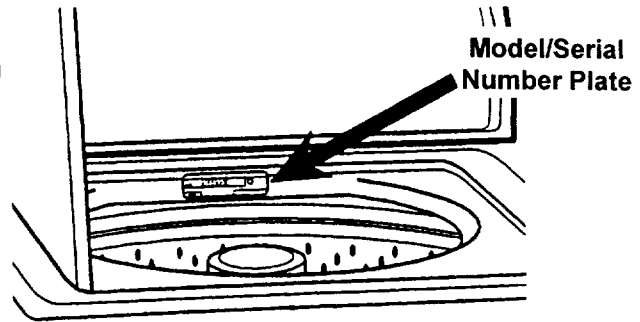

MODEL NUMBER DESIGNATOR

MODEL NUMBER	L	S	W	9	2	4	5	E	Q	0
PRODUCT GROUP	L = Domestic Laundry									
PRODUCT IDENTIFICATION	S = 27" Super Capacity Automatic Washer									
FEATURE CODE	W = Resource Saver									
CYCLES										
SPEEDS										
TEMPERATURES										
WATER LEVELS										
YEAR OF INTRODUCTION	E = 1996									
COLOR	Q = White on White									
ENGINEERING CHANGE	0 = Basic Release; 1 = First Revision; 2 = Second Revision									

SERIAL NUMBER DESIGNATOR

SERIAL NUMBER	C	H	36	50001
MANUFACTURING SITE	C = Clyde, OH			
YEAR OF MANUFACTURE				
WEEK OF MANUFACTURE				
PRODUCT SEQUENCE NUMBER				

GENERAL INFORMATION

CABINET REMOVAL

Cabinet removal and installation requires the basket to be pulled forward to avoid damage to the tub ring shield.

CLUTCH

The clutch is a six-pad design with a blue spring. It **MUST** be used due to the additional loads created by the recirculating water in the spin/spray rinse cycle.

NORMAL CYCLE

When **LOW SPEED SPIN** is selected, only the first two (2) minutes of the spin cycle is slow. The remainder is high speed.

The high agitation speed does not step down at the six (6) minute mark as in previous washers.

TUB RING

The tub ring has an additional splash shield stapled to it. The ring and shield are available as an assembly only.

FOAM STRIPS

Additional foam strips are glued to the inside front of the cabinet. These are provided to pick up droplets of water that may splash past the splash shield.

FABRIC SOFTENER

Consumers **MUST NOT** use fabric softener in the High Efficiency Spray Rinse washer. Consumers should be encouraged to use softener sheets in the dryer **ONLY**.

PRODUCT SPECIFICATIONS AND WARRANTY INFORMATION SOURCES

IN THE UNITED STATES:

FOR PRODUCT SPECIFICATIONS AND WARRANTY INFORMATION CALL:

FOR WHIRLPOOL PRODUCTS: 1-800-253-1301
FOR KITCHENAID PRODUCTS: 1-800-422-1230
FOR ROPER PRODUCTS: 1-800-447-6737

FOR TECHNICAL ASSISTANCE WHILE AT THE CUSTOMER'S HOME CALL:

THE TECHNICAL ASSISTANCE LINE: 1-800-253-2870

HAVE YOUR STORE NUMBER READY TO IDENTIFY YOU AS AN AUTHORIZED SERVICER

FOR LITERATURE ORDERS:

PHONE #: 1-800-851-4605

IN CANADA:

FOR PRODUCT SPECIFICATIONS AND WARRANTY INFORMATION CALL:

1-800-461-5681

FOR TECHNICAL ASSISTANCE WHILE AT THE CUSTOMER'S HOME CALL:

THE TECHNICAL ASSISTANCE LINE: 1-800-488-4791

HAVE YOUR STORE NUMBER READY TO IDENTIFY YOU AS AN AUTHORIZED SERVICER

